



A 2X



B 4X



C 4X

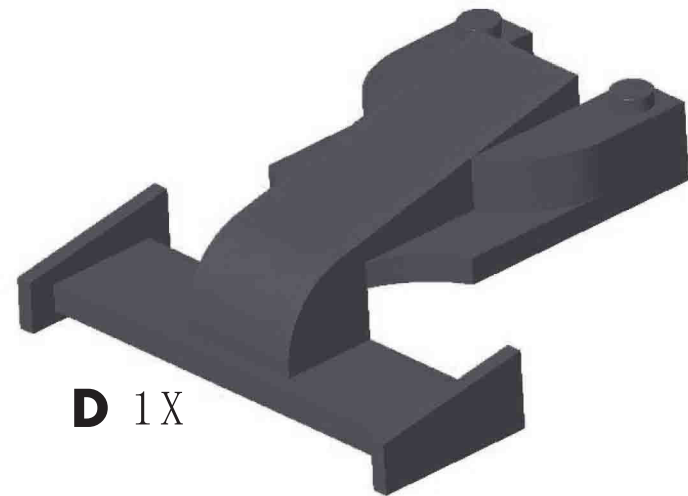

D 1X



E 6X

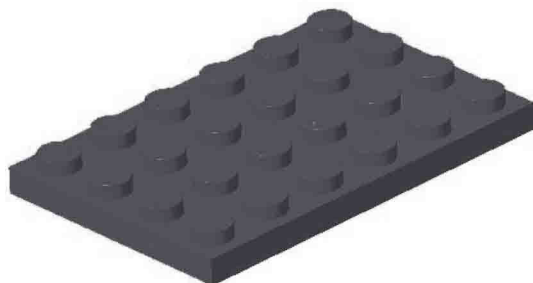

F 4X



G 3X



H 1X

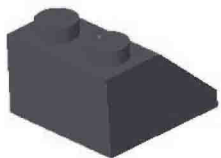

I 1X



J 3X

Step 1.

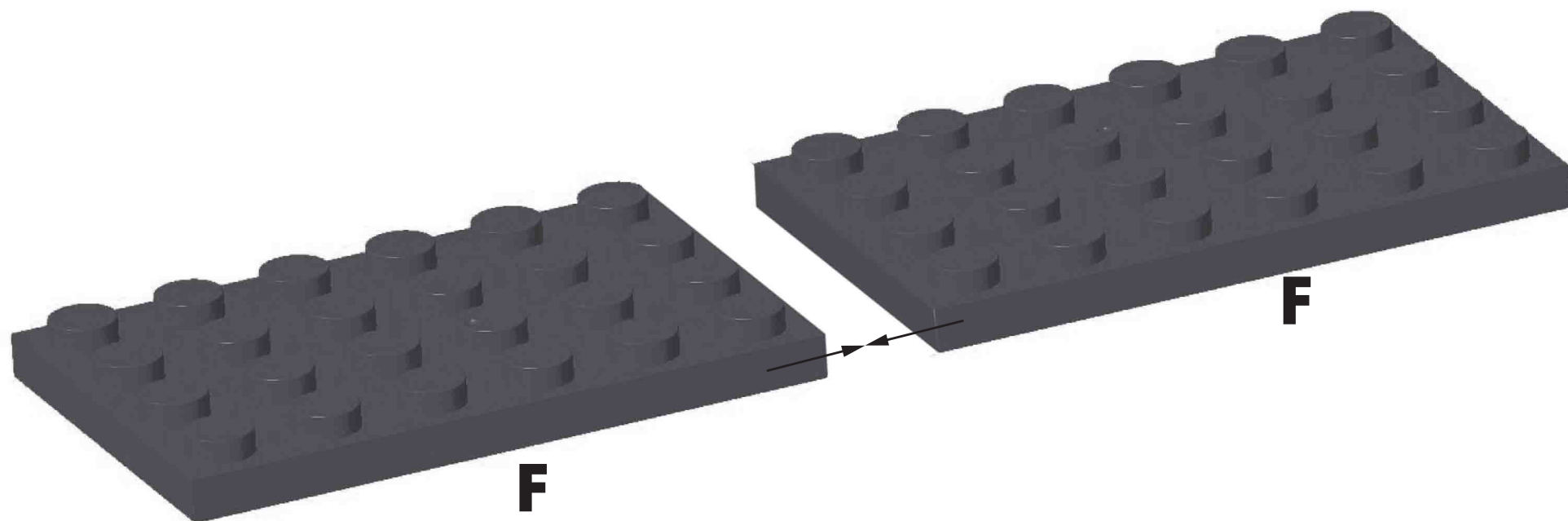

Step 2.

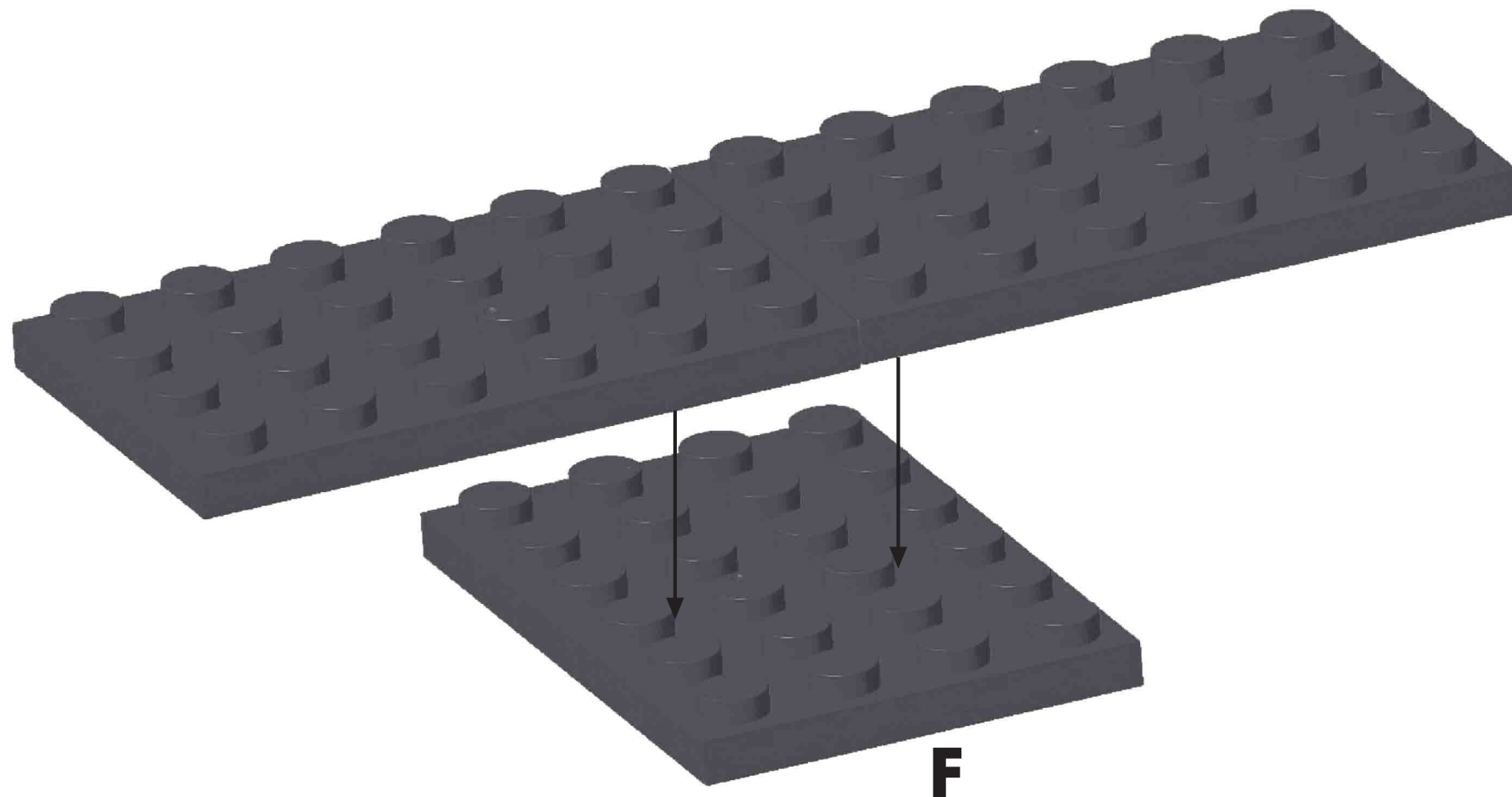

Step 3.

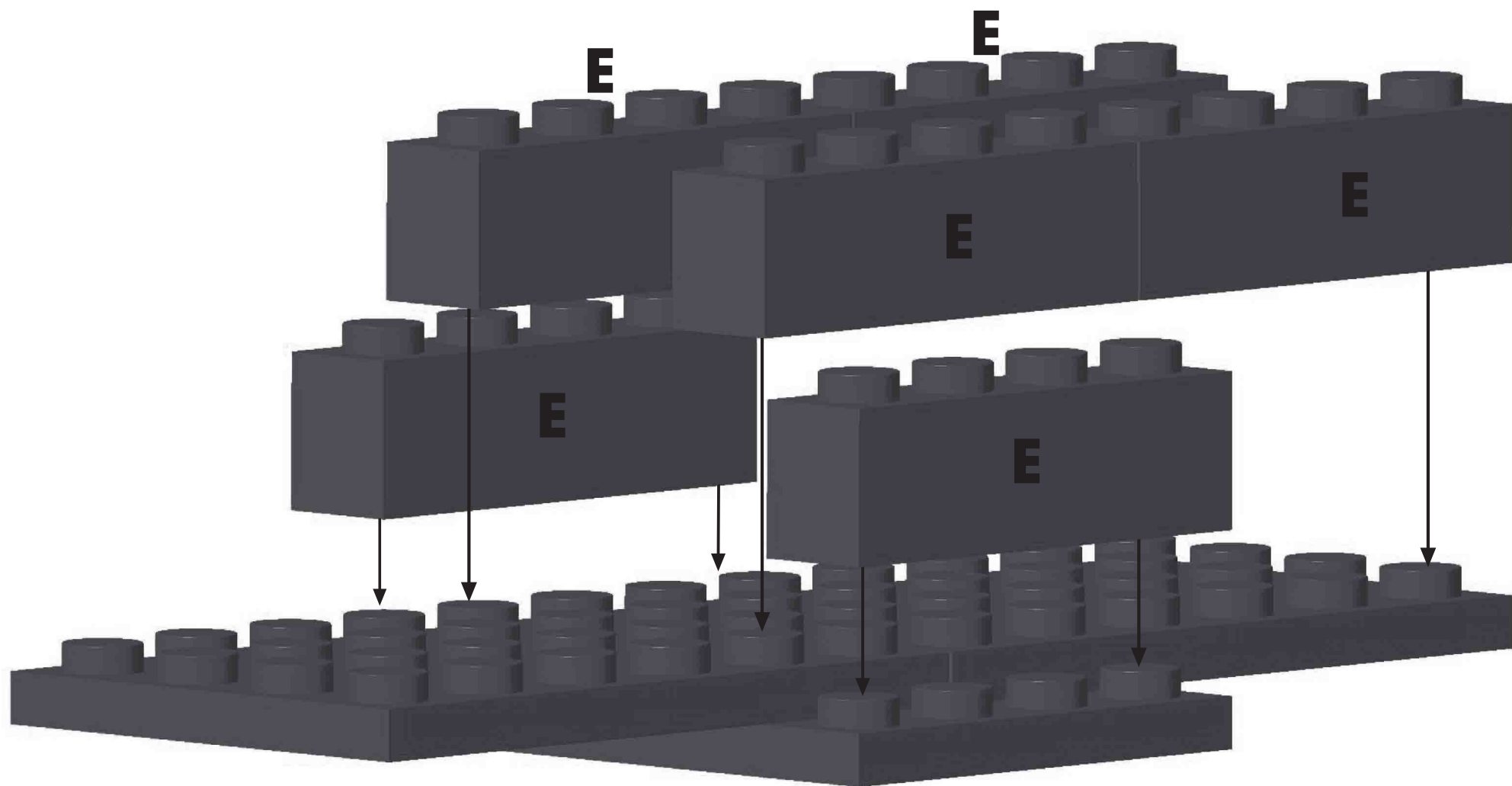

Step 4.

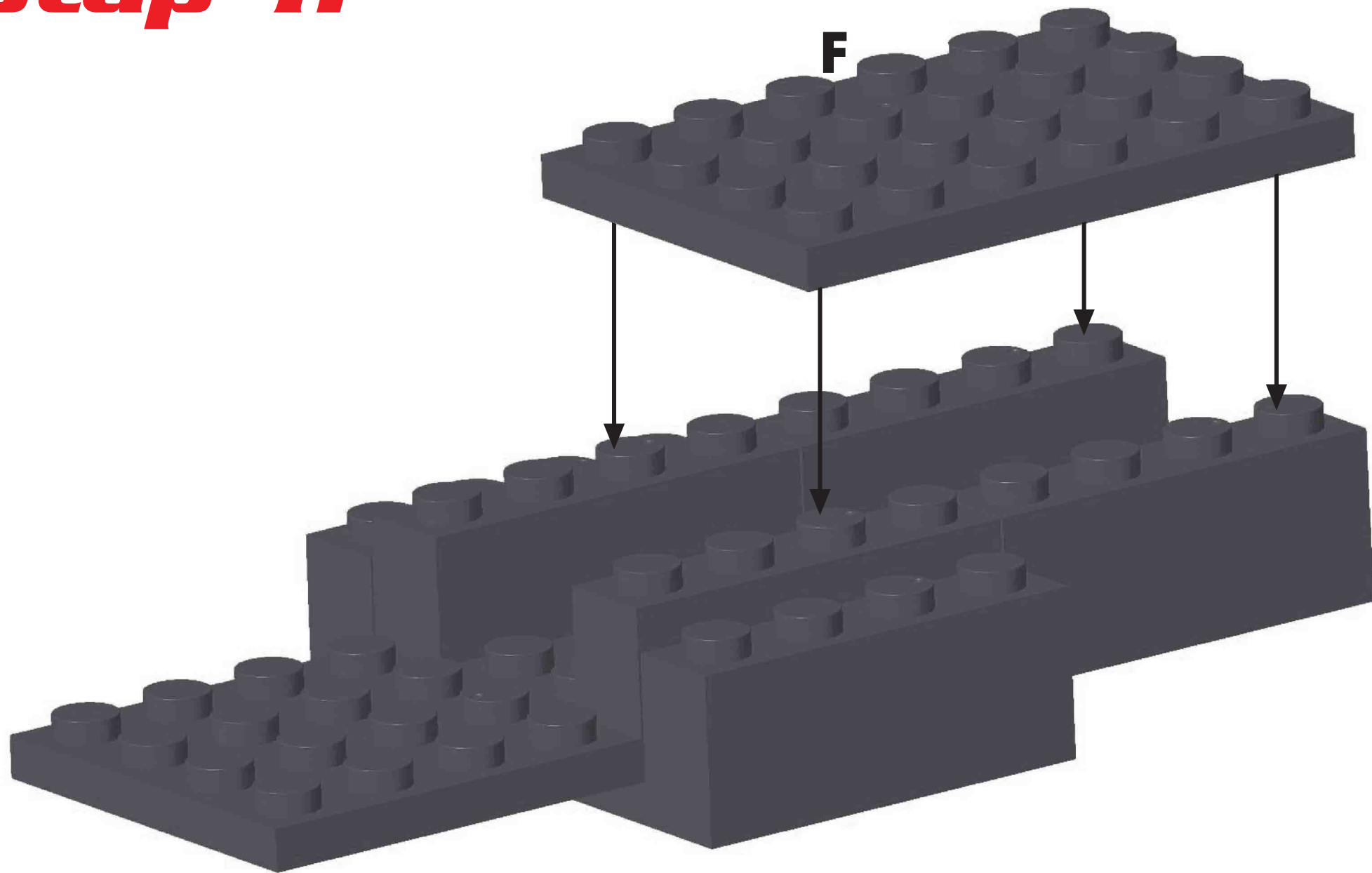

Step 5.

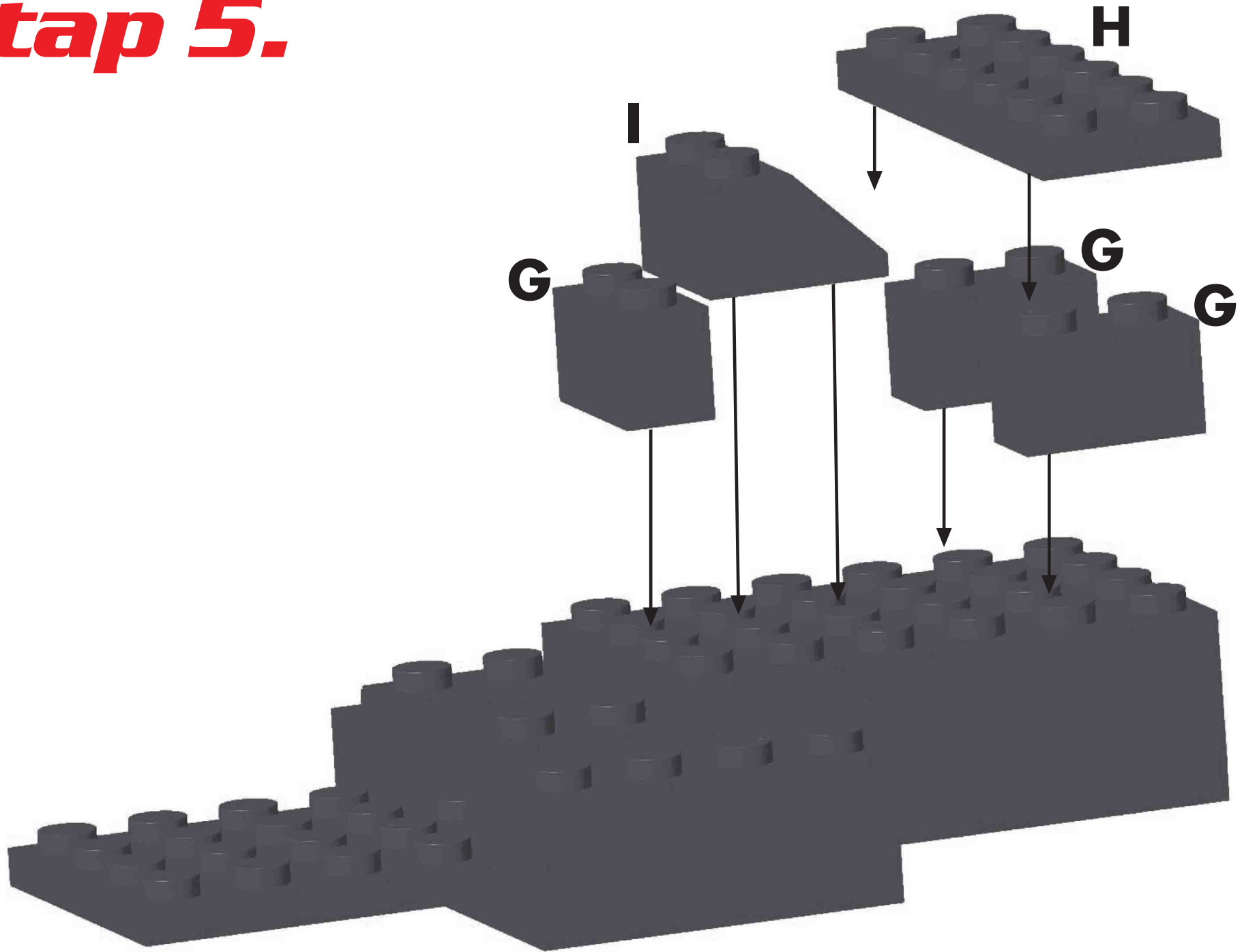

Step 6.

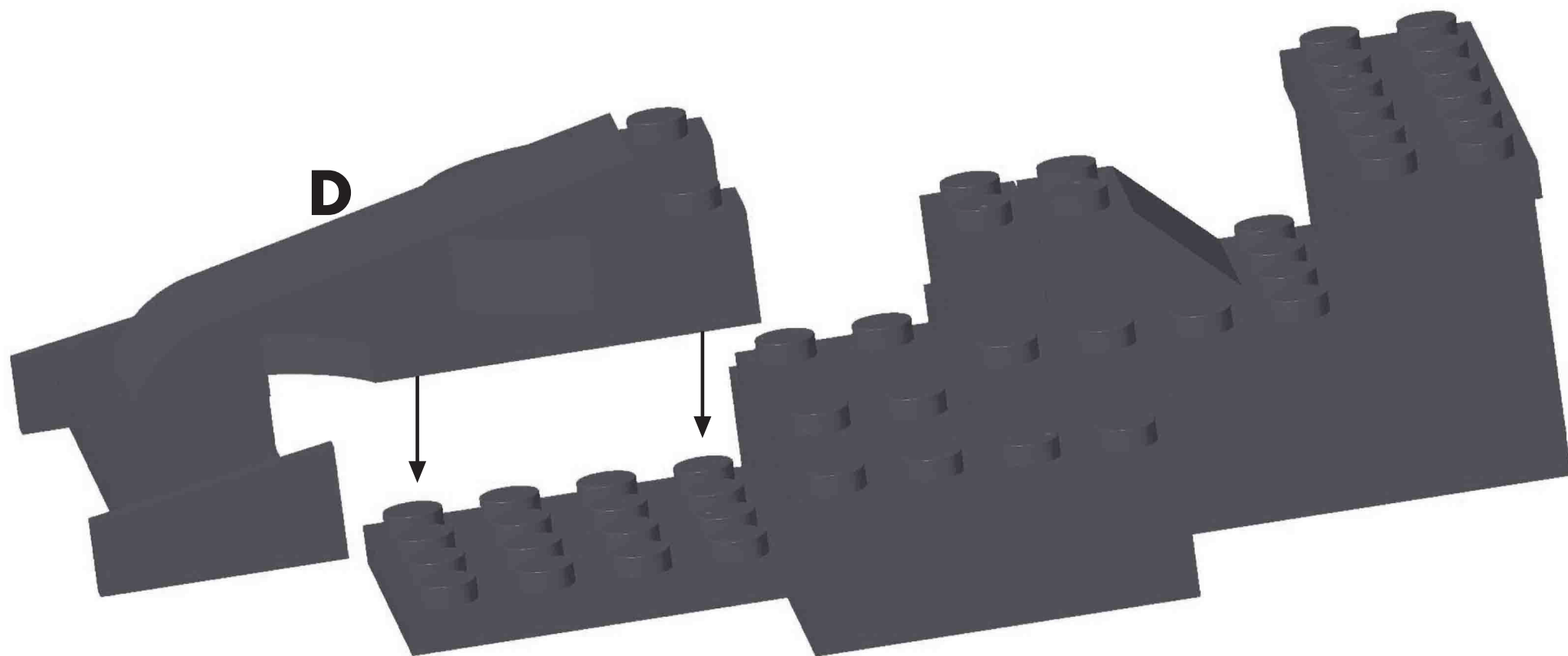

Stap 7.

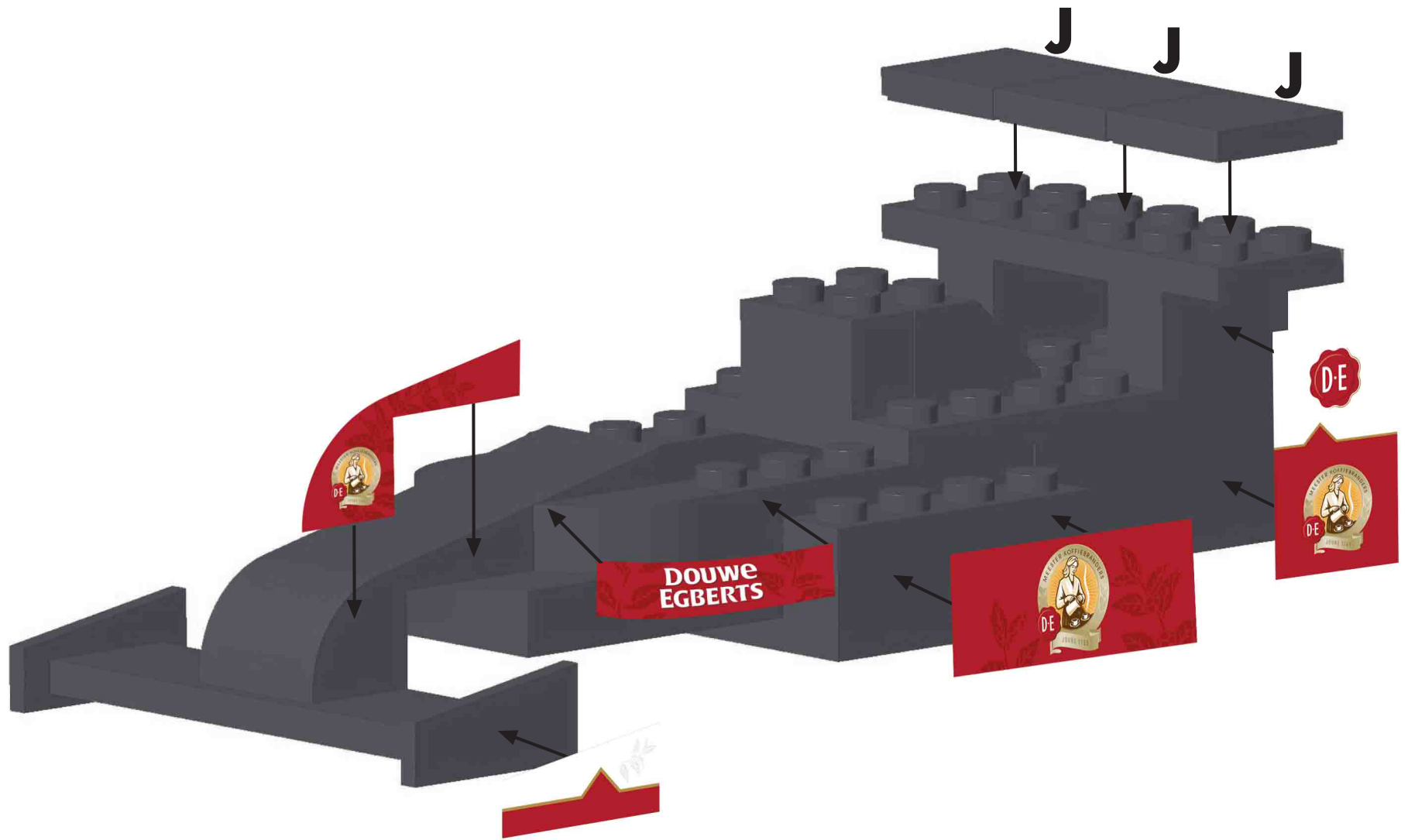

Stap 8.

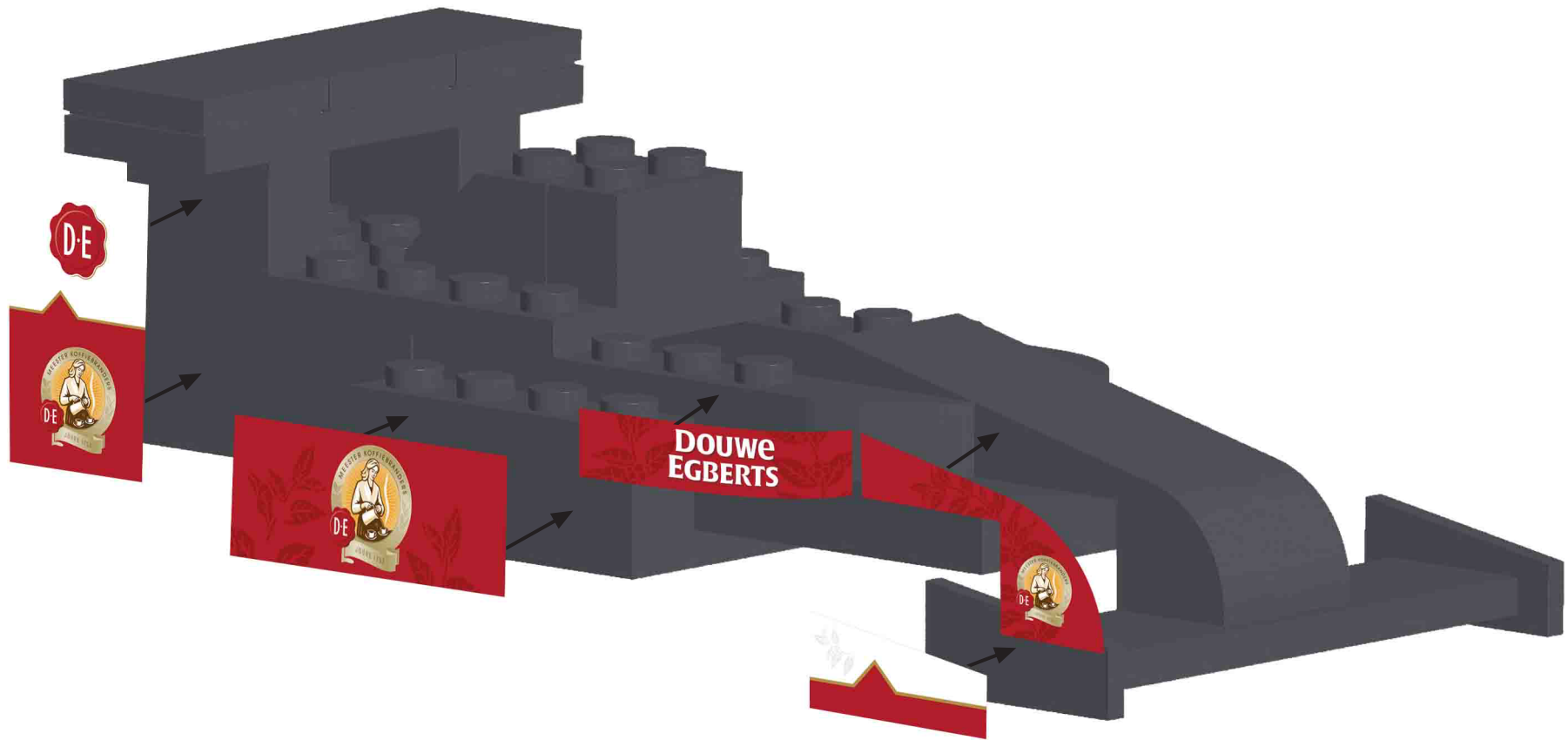

Step 9.

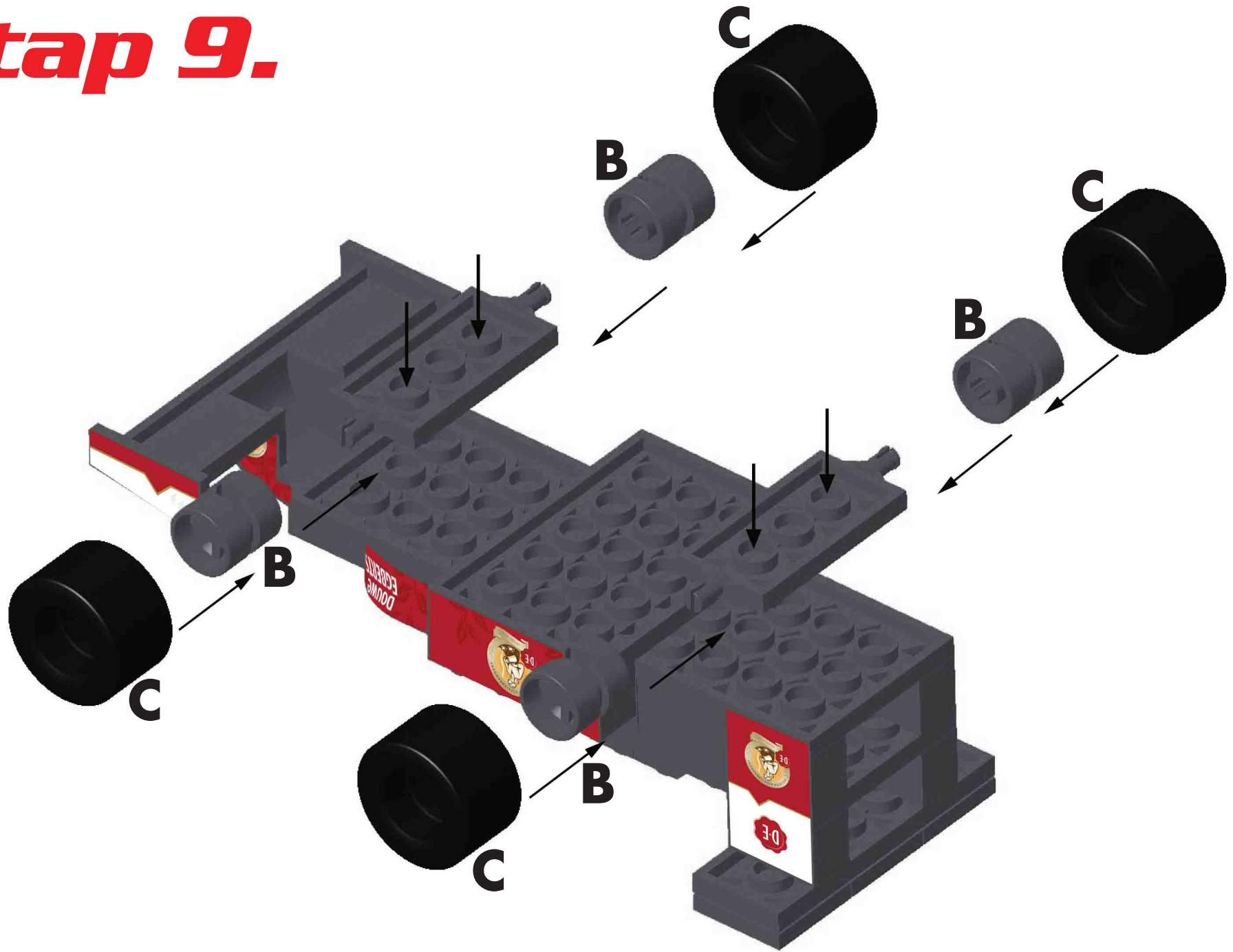

Stap 10.



K 1X **L** 1X **M** 1X **N** 2X **O** 1X **P** 2X **Q** 1X **R** 2X

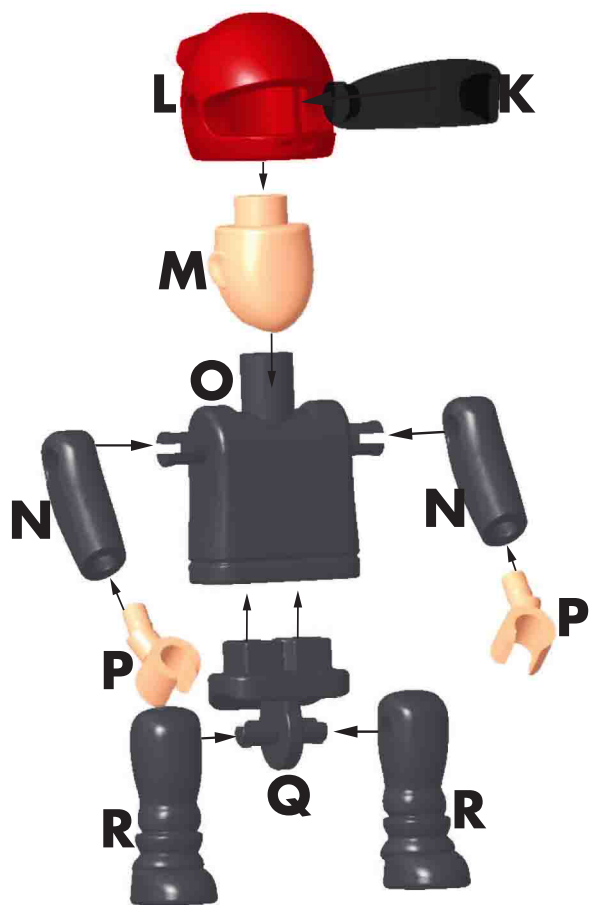

Stap 12.



